

Unit 2, 20 Kennington Drive,  
Tomago NSW, 2322.

**FAX 02 4964 9560**

# eUROFORM

Page: \_\_\_\_\_ of \_\_\_\_\_

Date ordered: \_\_\_\_\_

Date Required: \_\_\_\_\_

Customer: \_\_\_\_\_ Order Number: \_\_\_\_\_

Delivery Address: \_\_\_\_\_ Laminate Brand: \_\_\_\_\_

Telephone: \_\_\_\_\_ Fax: \_\_\_\_\_ Laminate Colour: \_\_\_\_\_

Contact Person: \_\_\_\_\_ Laminate Finish: \_\_\_\_\_

Edge Profile: \_\_\_\_\_

**33mm BENCH TOP PROFILES:**  HMR RAW  HMR WHITE

**38MM TIGHT ROLL**

Selected Laminates Only (Not available in Gloss)

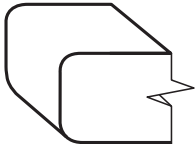

Tight Roll 6/6

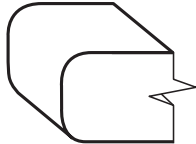

Euro Roll 10/10

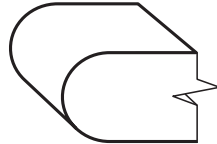

Bull Nose 180°

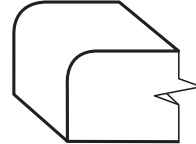

Euro Roll 90°

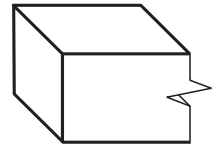

Square Edge

**LEGEND**    **||** = Rolled    **✘** = Laminated Square Edge

Nominate where you would prefer joins. Consider for ease of transport, Installation and access. If not noted, joins are usually positioned to suit economy of laminate sizes

Large grid area for drawing or notes.

**NOTE: 33mm & 38mm TIGHT ROLL BENCH TOPS ARE NOT AVAILABLE WITH END ROLLS**

## JOINT

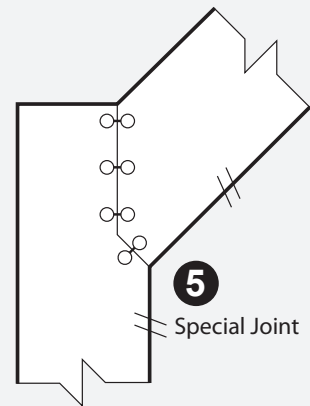
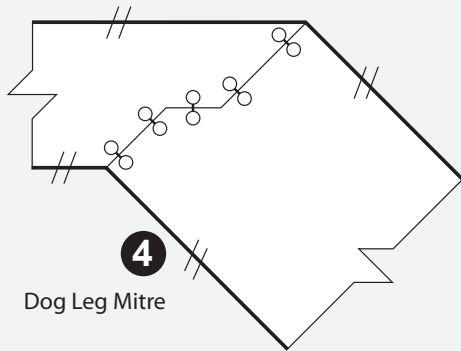
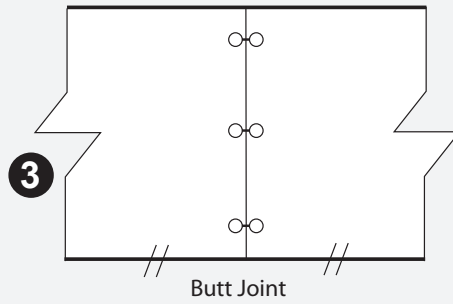
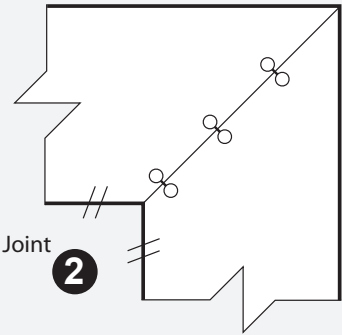
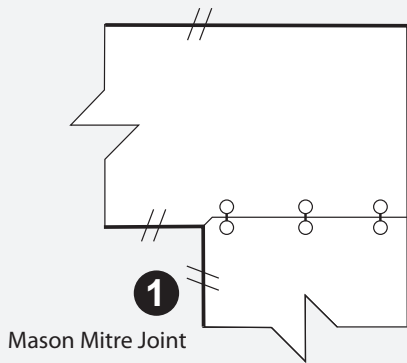

## FABRICATION

